

~~SECRET~~

NOT RELEASABLE TO FOREIGN NATIONALS

ORCON

GRILL FLAME

PROGRAM

SESSION REPORT

CLASSIFIED BY: MSG, DAMI-ISH
051630Z JUL 78

REVIEW ON: April 2000

Copy 2 of 2 copies

~~SECRET~~

~~SECRET~~

TRANSCRIPT

REMOTE VIEWING (RV) SESSION CCC-86

TIME

#66: This will be a remote viewing session for 2300 hours, 24 April 1980.

PAUSE

Relax and concentrate. Relax and focus your attention on building I. Relax and concentrate; focus your attention on building I.

PAUSE

Go to building I. Explore building I and report your perceptions to me.

PAUSE

+08 #10.5: I'm next to the pool looking into little overhang on two sides
+09 held up by posts.I'm in the big part.....

PAUSE

+11 I'm in like a utility room. I didn't plan on coming here. It's got something dark in the middle of it. Like a auxiliary generator, or something. Let me go back to the pool and go in another direction.

PAUSE

+14 I can see a single sleeping form. I feel like I'm in a living room type area. Got a feeling of nice carpet. Feeling of a good size picture window with a round low coffee table. Something big on it....big and round like a tall potted plant. I, I, can see past it and out in the front walk. Trying to find this guy.....he's in the middle "E" leg....he's in the middle leg.

#66: To whom are you referring?

+16 #10.5: Uh...sleeping form.

~~SECRET~~

~~SECRET~~

+18 #10.5: I'm in a walk-in closet ...off this room. He's.....
I don't think he's a hostage.

PAUSE

+20 Large bedroom, nice bed.....something at the headboard
feel like something dipping on one side (phonetic).....
something at the headboard that looks like dried wheat....
must be dried wheat. Stalks of wheat...lines like that.....

PAUSE

#66: Tell me more about the sleeping form.

+22 #10.5: White shirt, dark pants, clothed.....on the bed.....
When you told me that I saw a feeling of a rifle leaning
against the bed's head along side the bed on the floor.....

PAUSE

He's...uh...

PAUSE

+24billeted here. He's billeted here.

PAUSE

+25 #10.5: Somewhere near here.....I can see it through woods.....
Can see the house through woods.....I'm outside the house, and
I have a feeling of a gun crew....can see the house in the
background through trees. But, I have a definite sandbag low
half-moon sandbag skirt that's not that's not a dug position....
It's on a tripod. It's part of this crew. But, the weapon
points away from the house. I think I'm outside the big end.
Like the pool is on the other side. I think it points on farther
that way.

#66: Tell me about the crew.

PAUSE

+26 #10.5: Their position is in a concave curve in the woodline a little...
woodline in there.....right in there....maybe only 20 or so.....
feet back in.....keep seeing this thing.....

PAUSE

~~SECRET~~

~~SECRET~~

+28 #10.5: There are...I think two on the gun. May be several more back in the house. I see them (mumbling) cone (phonetic) to the gun. They come around the right side of the buildingthey go out of the building by the pool somewhere. Not the front of the building. They come out of the building by the pool and walk around to the left and then into the woods. It's only about 50 feet.

PAUSE

#66: Focus your attention back on the building again. Search through the building and determine if there are hostages there at this time.

PAUSE

+30 #10.5: Let me relax a while and go back and.....

PAUSE

+32 #10.5: I think there have been.....there are not now.....I keep
+33 looking to fill empty rooms with hodgepodge of people..... but then their rooms go empty again.

+34 One room in particular.....please show it to me again..... the room is off the living room on the right, in the front. Go right across the living room....go into the big back part.. ...and...uh...it's like it overlooks the pool in room in particular that I want. It's empty now. But, I want to have a clutter of mattresses and sheets and clothes all over. I have a feeling it was about master bedroom size, but it had everything taken out of it that was in there to make maximum sleeping room. Yes, I'm sure of it now....has a window on the left side of it which I think overlooks the patio area. I can see the right roof....light reflects about left out there.....

PAUSE

+36 That's still good.....I'm still looking around. When I asked where did the people go that were here... The area having the four identical house structures came to mind. As though it was a dotted line. Four of them that went right out of this window and across the pool in that direction. It was like I could see them far on the other side of the compound. I have no idea where I am now, but way over in hiding four regular white blotches of roof as though who had been here.....
+38 was taken over there.....but some time ago. Maybe several days.

#66: I have no further questions about the target at this time. If there is anything you would like to add, please do so now.

~~SECRET~~

~~SECRET~~

#10.5: No.

#66: All right fine. Take a big deep breath and move your arms, move your legs and prepare to draw those perceptions that you've had.

PAUSE

+40 #10.5: I keep getting a.....when I first started this session I had a feeling of a sandbagged window...but it had something funny sticking out over the sandbag....and I was just letting go. I wasn't even thinking about it again. I just kept letting go and get ready to come back and I got it again.. Some kind of a building face wall. The thing that sticks out of the window, but over the bags is.....when I first saw it I thought it resembled a firehose nozzle.....it had a funny fluting on the end of it. Fluting...it goes out and it gets bigger and it curves

+42 Where I think this thing is is near my touch down in the back of the building to the left of the pool. I'm still there, and I'm turning around to look for people..... no!....no, that's it.

#66: Ok. Let's draw.

#10.5: Ok. I had a feeling that I was on a..uh...like I was right at the back corner of the building and there was some sort of a little overhang on the roof.....enough to be like a covered walkway. But, it was held up by posts. Ok. It went down. There might even be posts here along this part.....real patio type flair, you know. Pool is here....first I didn't think there was any water in the pool, ok. All right...then like that was the corner of the structure. Went that way. Ok. So here was 1. This was my entry type. So what I figured, since I was closest to this on the left of sketch 1, I went through that wall. In that wall, all I ended up with was like a utility room type of a feeling, that had like, a, had the feeling it had..uh..maybe an auxiliary generator in there. Or something like that, that was dark, painted black, you know. Service black type situation. Then, I figured well just my dam luck to pick the wrong place, you know....waste time. So I backed out of that one again, and I.....I thought it might have been a utility room, because I had the feeling like, water heaters, clothes washer, dryer type stuff around the margin of the thing. Ok. So on 1...utility room, auxiliary generator sitting in the middle of it. Washer, dryer type situation flash up. So that's for 2.

Then I got this sleeping form. I had no idea where it was so I actually left it. I just had a...just a sleeping form of a guy. I figured it wasn't going to do me any dam good because

~~SECRET~~

~~SECRET~~

if it was a hostage, I still had to find out where it was.....
where he was.....so much for that.

So, I went and I explored the house some more. I was trying
to find out where this guy was. What I did, in essence, I
went back again to start, the number 1, and I tried to go
in the crotch of the building which would now be.....guess 4.

So 4 was through that wall. Got a living room lash up,
windows...uh...foreground shot, like this. A feeling that there
was something on the right side. Like these ornamental posts
that you have in a kitchen type thing.....kitchen type thing.
Standard sofa. Living room unoccupied. That's what....4.
I got the feeling this guy was around there. Sleeping man is
somewhere there. Somewhere around to the right in sketch 4.

So I bopped up above the building.....I tried to figure out where
he was.....and my attention was being drawn to.....what I called
in the transcript the middle part of the E. The building is
shaped like an E on one side of it. The two Es are separated
by twothese things are separated by a small courtyard
and a large courtyard. Like this. Of course I know this
from the imagery. My beacon method was to form this odd shape
E thingand the X on sketch 5 is where this guy was sleeping.
So then, I went back in...how I knew where the hell he was....
then I went back in, and I had a ornate...more ornate....I mean
a nice bed type situation, and there was something funny here.
Something funny here on the right side of the bed...like the
headboard of the bed had a shelf on it. You know. Like the
lady's side of the bed had a shelf on it, and on this shelf
was a pot that had dried straw or winter flowers. You know
how winter flowers look? They're dry and their very pretty...
different hues of earth tones. Anyway so much for that.

And, I had el-sleepo man clothed sleeping there on the left
side of the bed. When you asked me who was this man, or what
was happening...boom, I got the idea of a weapon...like leaning
here against the headboard. Whether that's symbolic or actual,
I don't know.....window on the left side. White shirt, black
trousers on the guy. And, I think this window on the left
side of sketch 6 looks out into the large courtyard, here.
So that's where this cat was.

Ok...Uh.....where am I on the notes. Oh! Then I was exploring
elsewhere in the building and I had the feeling.....now I know
what I'm talking about, ok.and I had the feeling.....
that off the living room...which is sketch 7....off the living
room.....this is like the back door.....like a patio door....
like a sliding glass patio door.....and these might be those
upright things that I annotated in the other sketch.....

~~SECRET~~

~~SECRET~~

The sleeping man was around this corner. Seven is a living room shot looking into the house. Sleeping man.....ok.... and a place where hostages were. And, I underline word on it.....is around and to the right. The idea.....that placeis like around the corner to the right, first door, left, is a room or....somehow you go back out and the window of the hostages room looked on the patio where the pool was. So for 8, oh, go back to sketch.....no I can't do it.....

- #66: Ok. Pretty quick here now, you started talking about, you spontaneously zipped outside and found those gun crew, or something.
- #10.5: Does that come first, or does that come after this. Did I start talking about where hostages used to be or where they are? Which one came first?
- #66: Your gun crew came first.
- #10.5: Ok. Let me do that. All right. I had the feeling of a... uh....non-dugged in but sandbagged position....low, low bagging on it.....maybe 3 layers....just enough for a gun with a tri-pod to sit over or point over, ok. I tried to figure out what kind of a gun it was, but I just couldn't. I knew it was there.....black and it was ugly.....and it was....did it's thing. Surrounded by trees...almost trees, almost out in front of it.You know. Trees are like right along the side of it and a couple in the background. And, behind it, I could see the building. I think it was the same place. I do think I was just outside. Uh.....ok. You can see it peeking through the trees, and, maybe a couple of windows in there. Like that. And, the distance is maybe, maybe 50 feet. But, it's covered over, you know. The trees are around it. But, that somehow, out this way, this is actually located on the edge of an open clearing...and it's like tucked back in under the trees. This is the target building. Around here is the pool patio.
- #66: Ok. Can you go to another page and draw an overview?
- #10.5: Yeah. For 9 I did hop; up. Ok. There are trees around here...oops, and these trees make almost a crescent, ok, and about like, right here, is where the gun is. Ok. Ok. I'll also use this overhead for the next series.....this is number 9, on number 9.....when I was in.....I'll draw the dotted arrow, that the direction which the previous hostages had been directed in was in that.....I had the feeling like catty-corner across the pool patio....out from here in that direction.....ok.....More trees around here. Ok. And...uh...X, on the spot, that's sleeping man; X...old hostage location, and then right at the very end of the session, I was back outside one more time, and I had the

~~SECRET~~

~~SECRET~~

feeling like there were like two, two people lounging around a...outside patio type...chairs that were there. Right against the woods, between the pool and the woods. I mean they're lounging. They're not in their skivvies. They're lounging...you know...sitting on their butts at the...I mean they're dressed, and everything, situation. Ok.

Ok. The feeling about the old hostage room was that I could peek out the left window and see the pool, ok. So it would mean to me that it might be a little bit farther back along that big blocky part...rear part of the building. Uh...it was off the hall. I tried to look around, and see if there were any other places like that, but I had the feeling that I was looking at essentially a bare room that everything had been moved out of, and the one minute, when I first looked at it, I said there's something interesting here, what is it. There's nothing in the room. Then I saw like all sorts of blankets and stuff all over, and then it disappeared again, and then it came back again, then it disappeared again. And, then I asked myself, where did these people. And, I looked up, and I looked catty-corner out the window and across the pool and I went like...vroom...zoomed in like the zooming with the camera lens, and I saw, I just had the gut feeling, the knowledge that they had gone from that point over to one of the four buildings that are in a row. The four small houses. Because, I recognized the pattern...just sort of intuitively I said, oh, it's those four houses over there. But, which one they went into, I don't know, but I had the feeling maybe 7 or 8 people had been in that room, and then they had been taken away some time earlier than that.

#66: How about the rest of the building. Aside from the man that you told me about before...do you have any opinions about the rest of the building?

#10.5: No. I tell you it was unoccupied. I'd say, if anything, there might be a small group of the people or occupants billeted there or gun crew. But, I wasn't able to get into any other places. I kept asking myself this big question, Ok. Where are they? I only went to two places. So, I'd have to presume there wasn't any real relevance to the rest of the structure. That's the only real relevance.

#66: Ok. So you would say that the building is now, at this time, unoccupied or

#10.5: No hostages.

#66:no hostages in this building.

~~SECRET~~

~~SECRET~~

- #10.5: That's what I'd say. Ok. If it is occupied, again they'd probably put them right back in that same room.
- #66: Ok. Anything else you want to add?
- #10.5: I want to do this funny window.
- #66: Ok. This is the thing that you had at the end.
- #10.5: Yeah. And, I had it at the beginning too. And, then it just popped back to me. I think it is along the back of the building, or what I would call the back of the building, and it was the funniest thing. It was like a higher window there.....that had the appearance of having been bagged off.....I mean the actual window.....having been bagged, sandbagged off, and sticking out through this thing was this tube. So for 10, I'll do a quick little ...quick insert.....feeling of these sandbags,I screwed that up, didn't I.....feeling of these sandbags.....and protruding out from this thing was this..... you know what a firehose nozzle looks like.....it's like that. It's fluted at the end.....ok.....it splays out at the end....comes out like this all around it..... and this thing was sticking out. I almost....I almost..... I actually said to myself, that's funny as hell! What the hell somebody got the firehose nozzle pointing out of the window for? You know. What comes out of that thing. Then, I just said, well, you know, that's probably just garbage. To heck with it. Just something weird. Then, I went on with the rest of the session. And, then when I was.....you asked me if I had anything more to add.....and I said no.....and the next thought that popped into my mind, was this damn thing again. Ok. And, it's metallic; it's all the gestalt things of a big ass of a big firehose nozzle. Big, two man nozzle type thing, only all I could see of it, was just the end of it. So, I don't know if it's a sump pump or could be an automatic weapon, or something like that. You know. Put in the window. It was very, very spontaneous. Thing protruding from partially sandbag window shaped..... like a firehose nozzle. Ok. That's all I got.
- #66: Ok.

~~SECRET~~

TAB

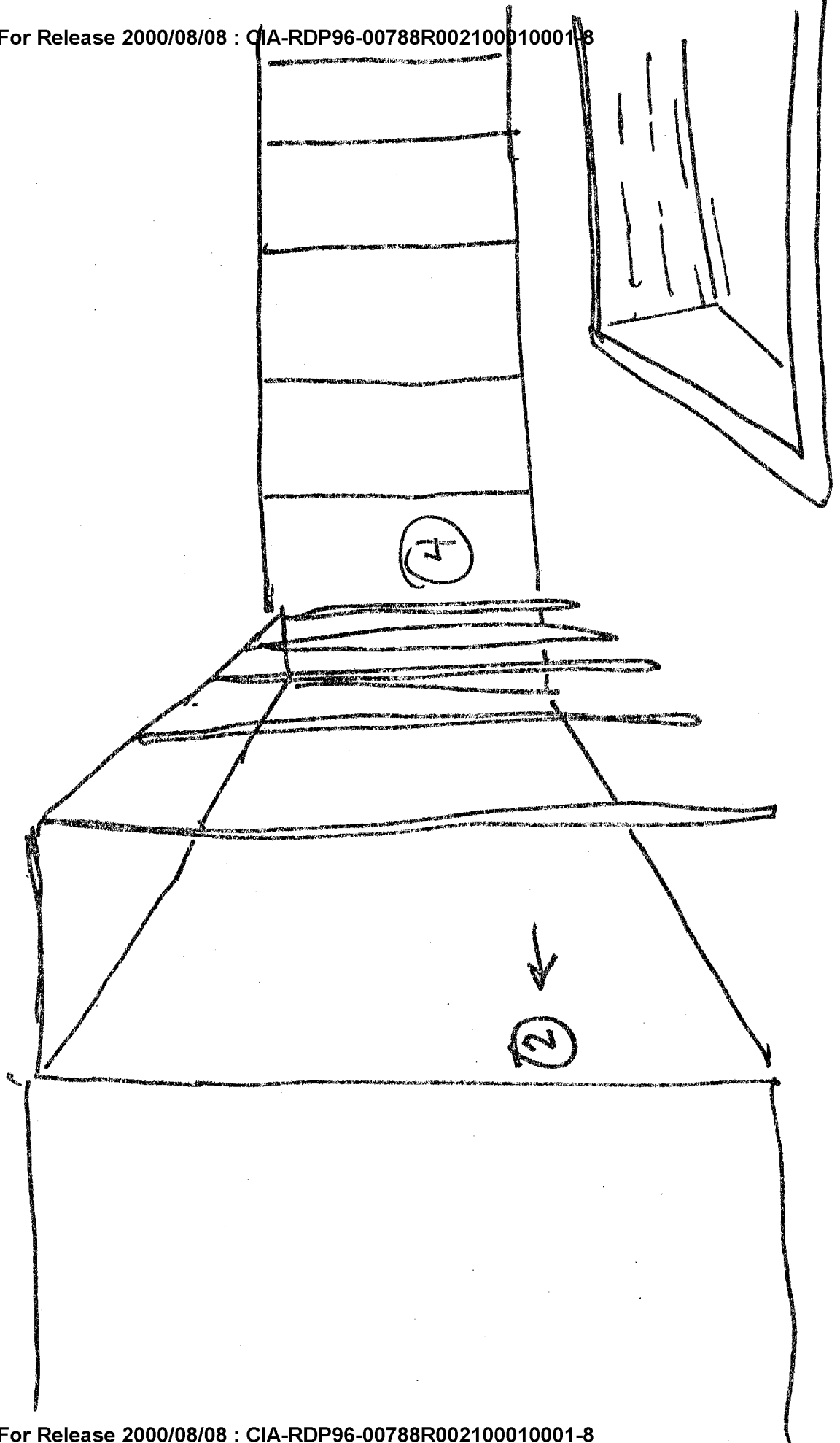

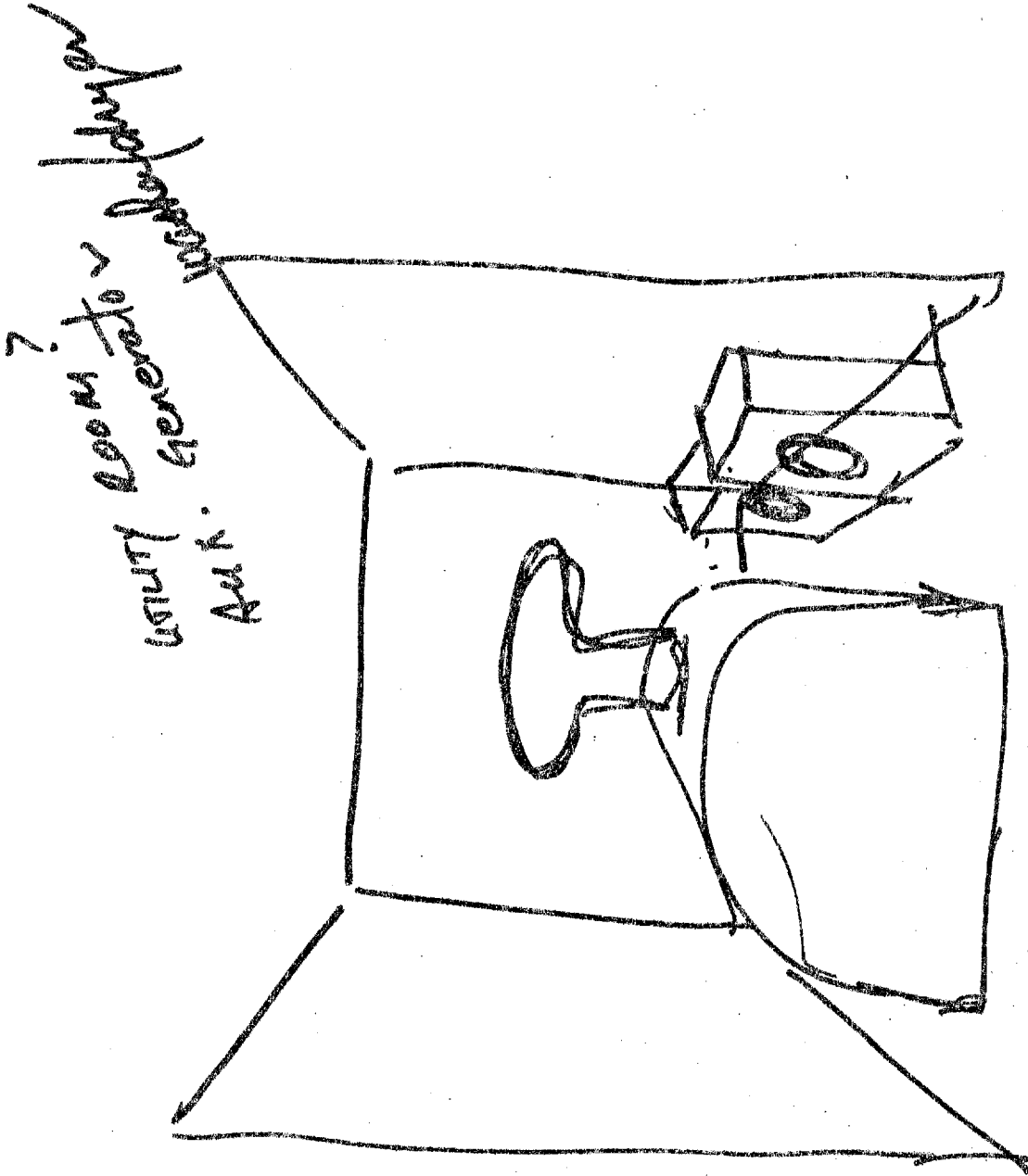

sleeping man
bedclothes

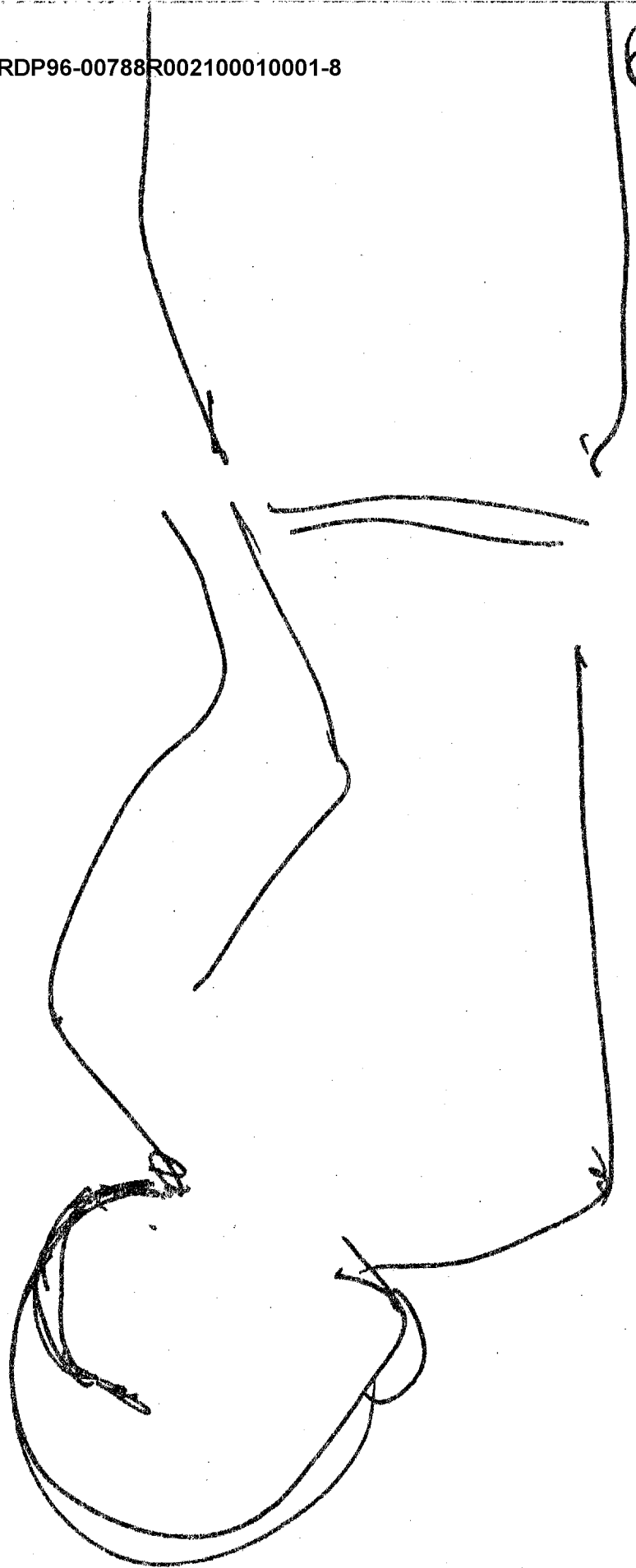

(4)

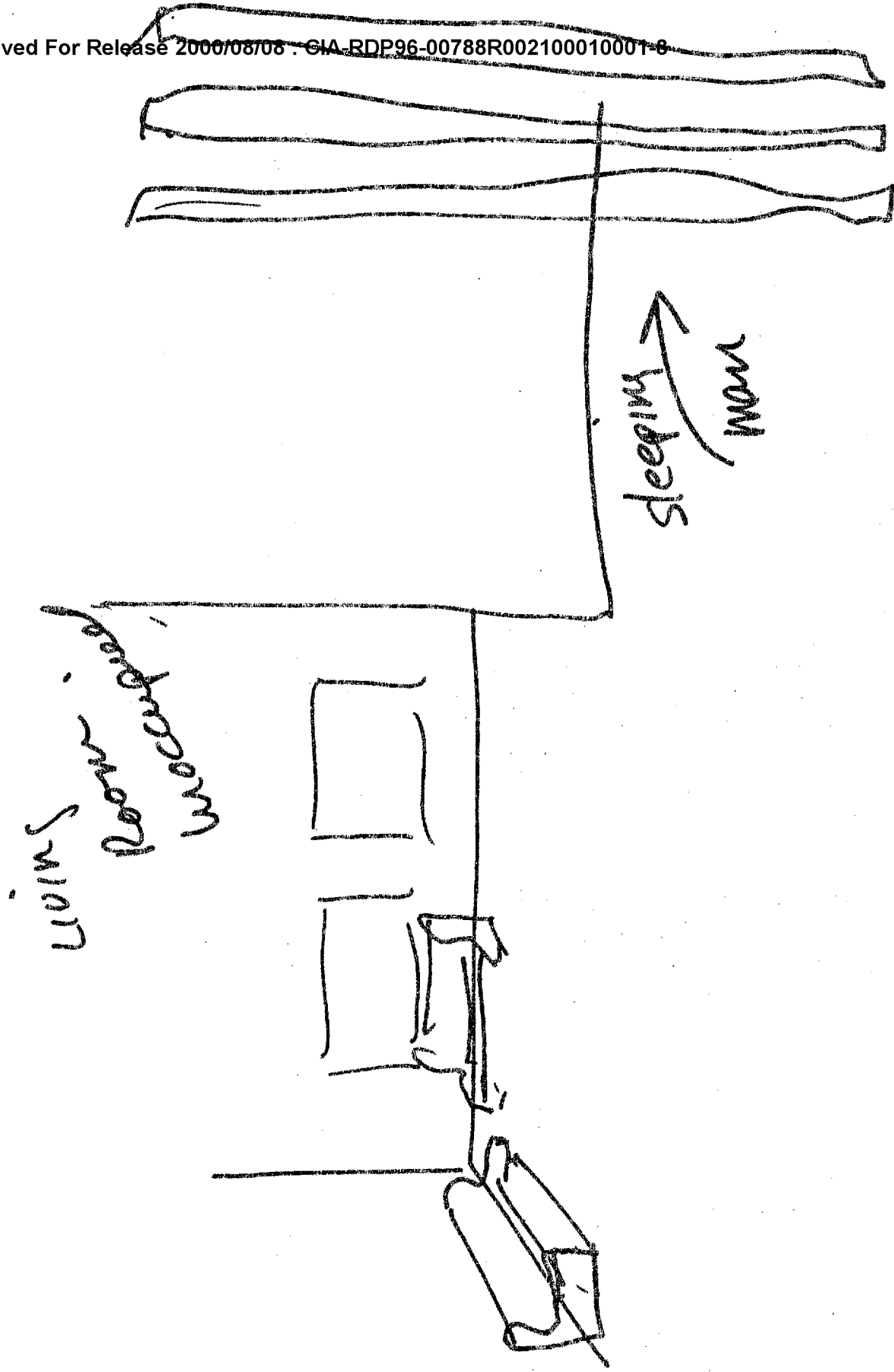

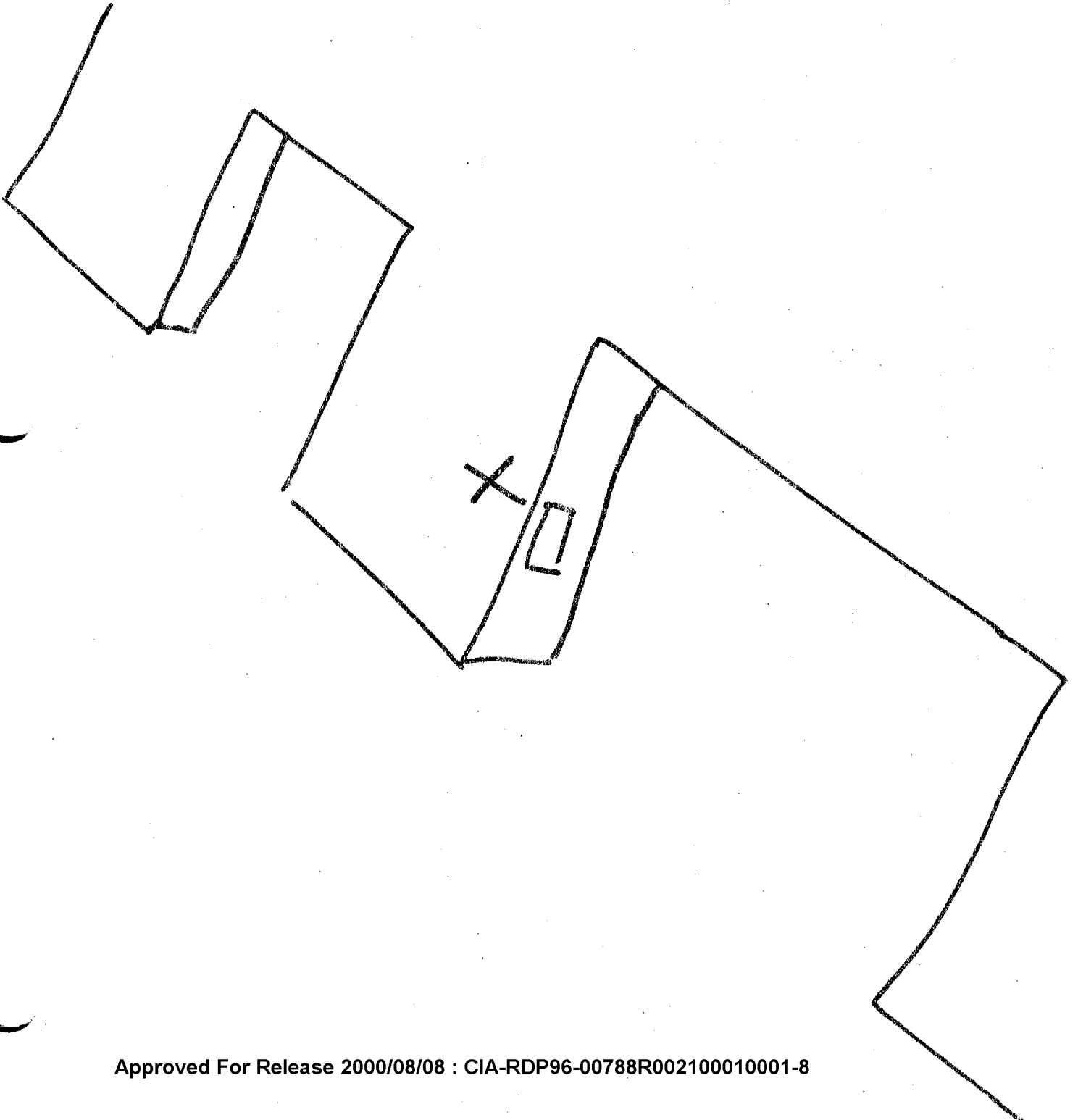

6

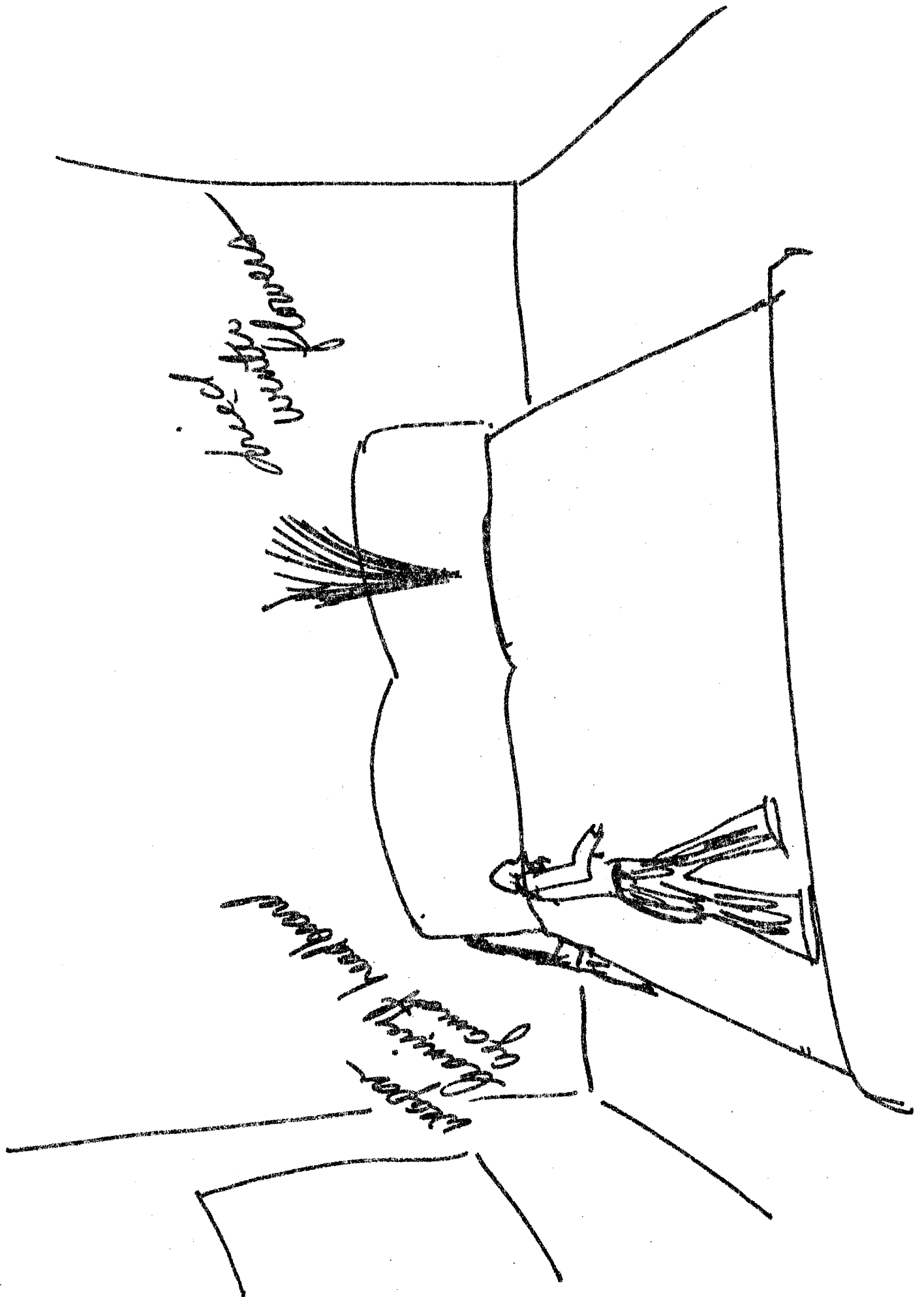

(A)

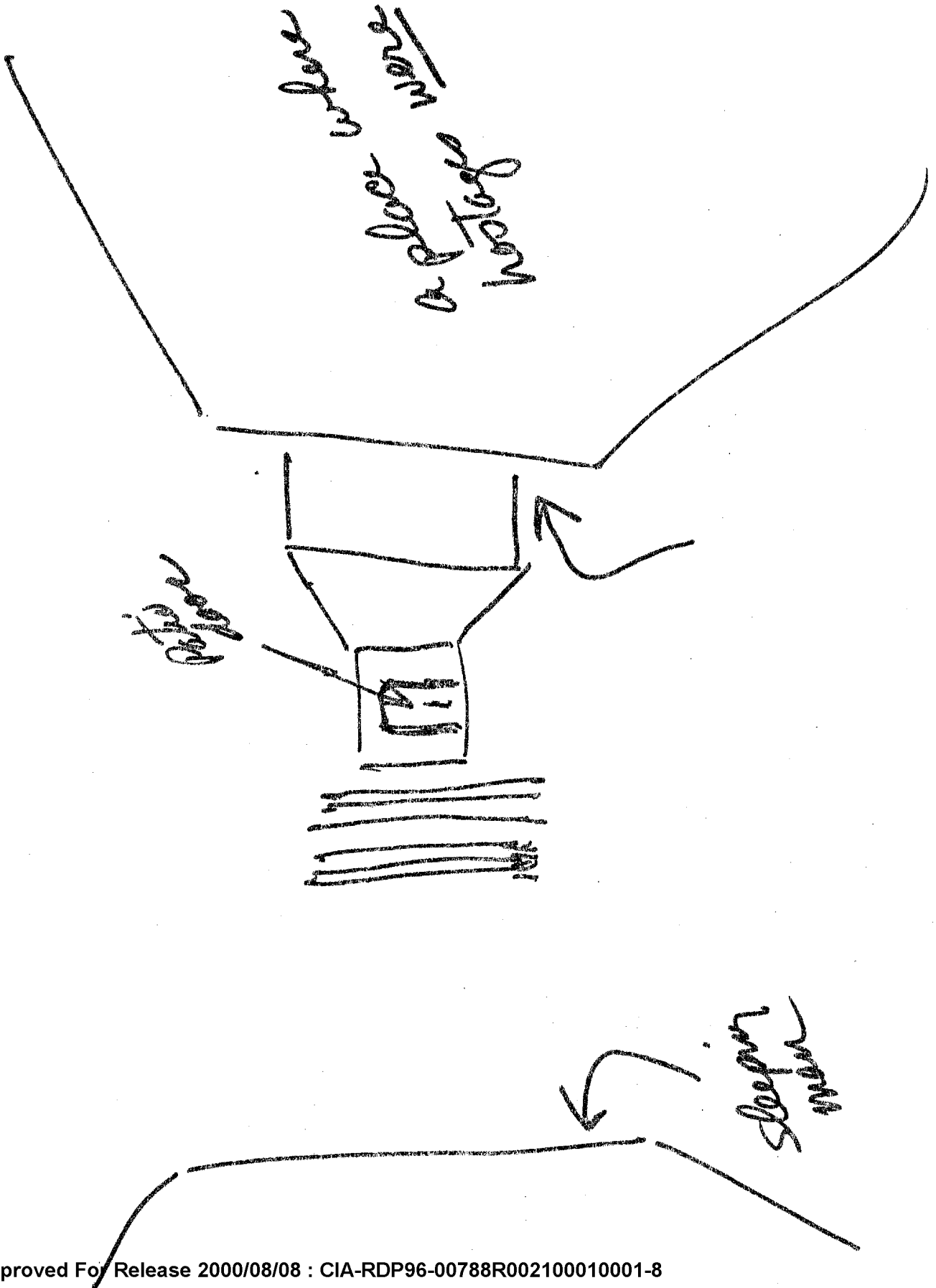

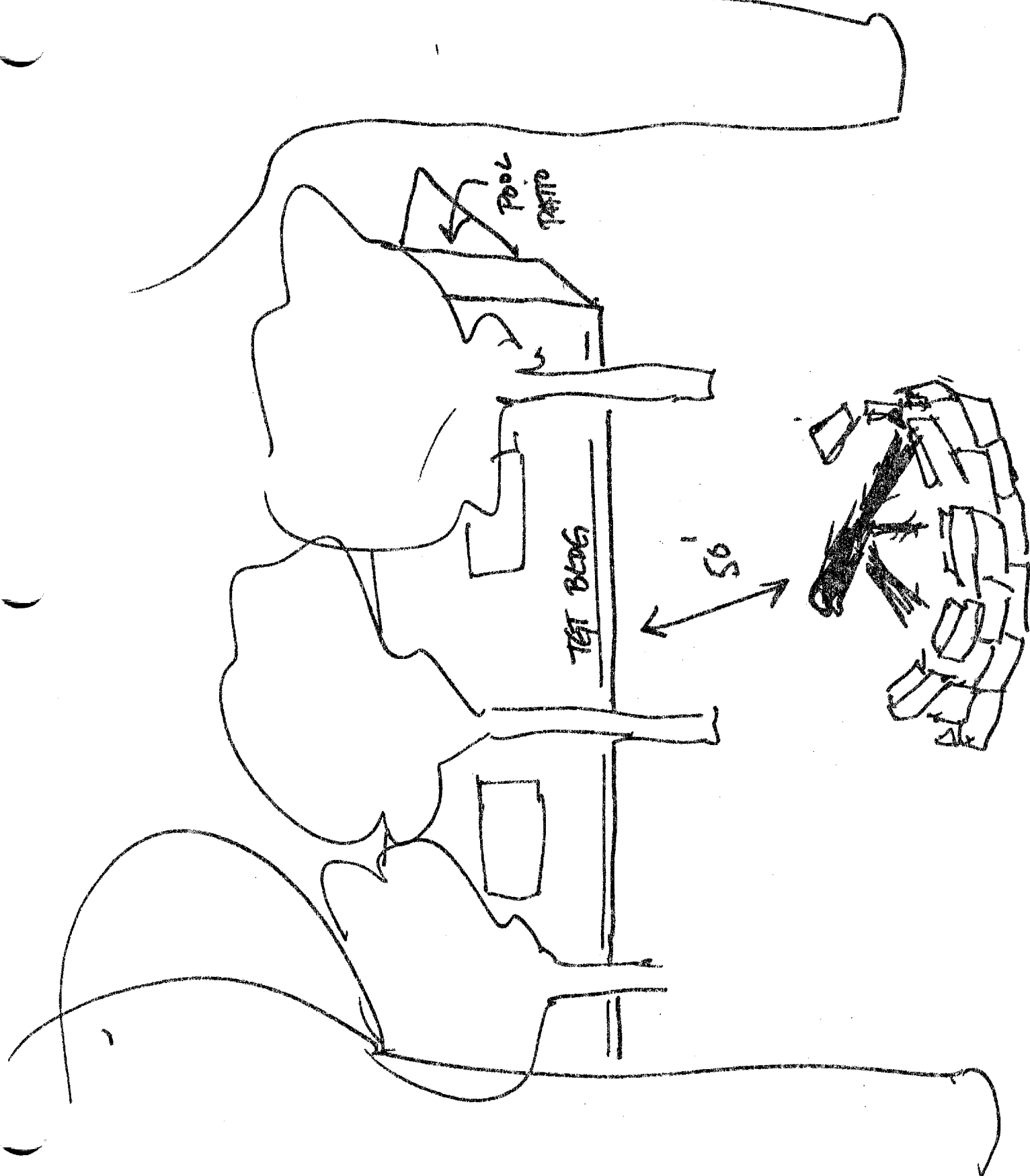

9

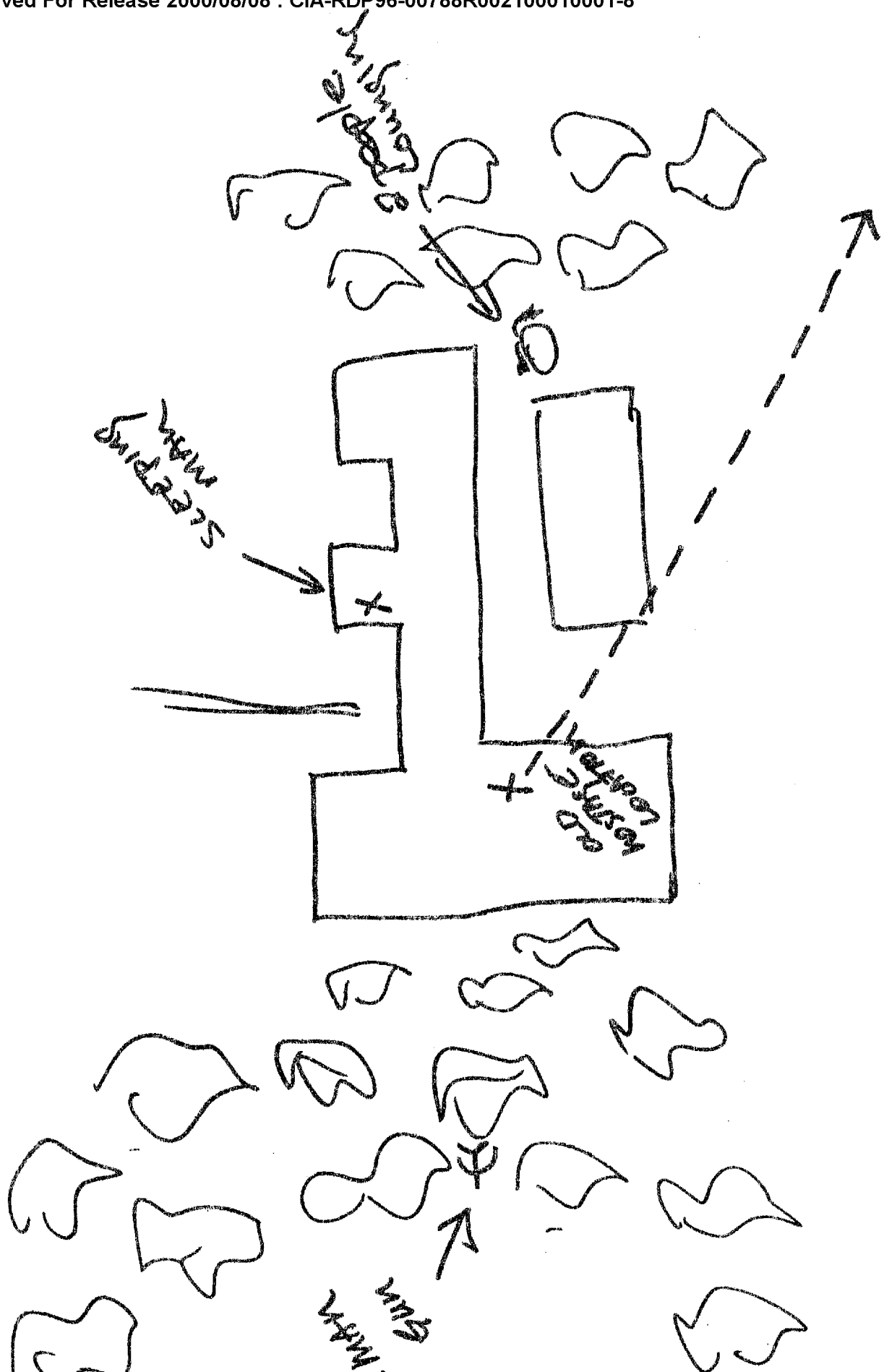



SG1A

Approved For Release 2000/08/08 : CIA-RDP96-00788R002100010001-8

Approved For Release 2000/08/08 : CIA-RDP96-00788R002100010001-8